

Effective April 2019

freerit

PLANNING GUIDE



Application - Benching

Configuration

- Single Sided
- Back-to-Back

Worksurface Depth

- 24"w (without grommets)
- 30"w (without grommets)
- 24"w (with grommets)
- 30"w (with grommets)

Base Height

- Standard 2-stage
floor to top of surface height adjustments ranges are 27.5" - 45.5"
- Extended range 3-stage
floor to top of surface height adjustments ranges are 22.6" - 48.8"

Dividers

- Fabric (tackable)
- Glass
- Laminate, frameless
- Laminate, framed

Optional (upcharge applies):
framed laminate panels only

- Whiteboard
- Magnetic Whiteboard

Dividers on back-to-back stations

- Table mounted dividers
(screens will move with table)
- Back-to-back dividers
(screens are stationary)

Electric

Infeed

- Base
- Ceiling
(cable manager included)

Duplexes (amount)

Duplex Color

- Black
- White

Wire Management

- Cable chain

Standard Electric — 8-wire, 4-circuit, 2+2 — additional wiring schematics are available, contact customer care

Base Storage

Mobile Pedestal

nested storage must be no higher than 25"

- Laminate
Zira, Sidebar, Princeton, Bridges II
- Metal (specify Global metal filing)

Pantry Storage

- Laminate 49.5"

Storage Modules

to sit outside stations creating a return

- Laminate
Zira, Sidebar, Princeton, Bridges II
- Metal (specify Global metal filing)

Additions

Accessories

- Single monitor arm
- Double monitor arm
- Freestanding task light
- PC holder

Desktop Modules

- Data only
- Electric only
- Data and electric
- Electric and USB

Height Adjustable Base

- Digital handset
- Extended glides
- Whisper quiet insulation

Seating

- Task

Global recommends a specification check for all product applications.
These can be sent here: <http://specification.globalindustries.com/SpecRequest/>

CONFIGURATIONS

Single Sided

Table mounted divider measures 44.5" h above finished floor when installed.
Dividers move with table.

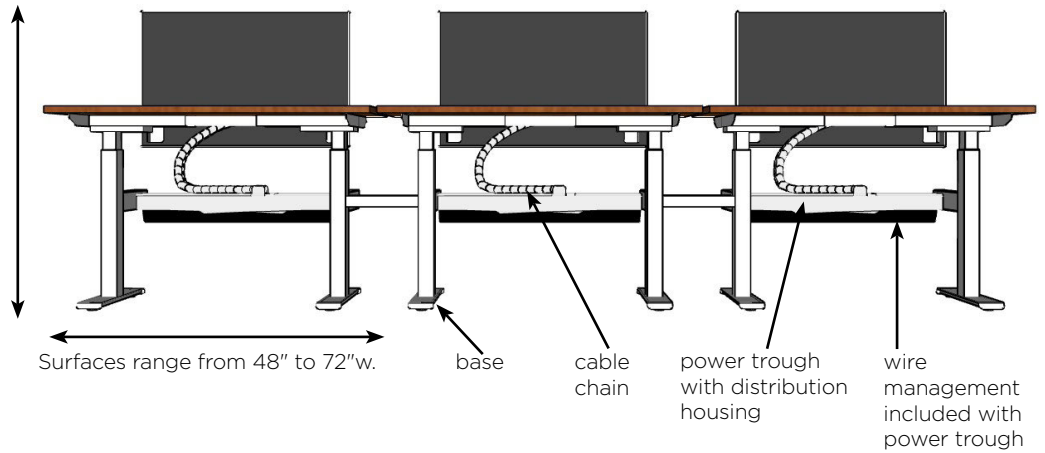
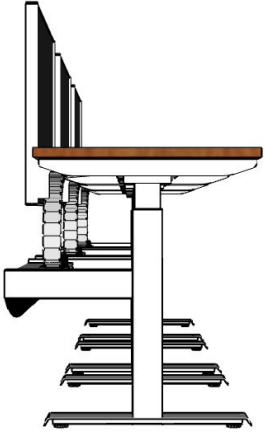

Back-to-Back with Back-to-Back Dividers

Divider measures 54" h above finished floor when installed.
Dividers do not move with table.

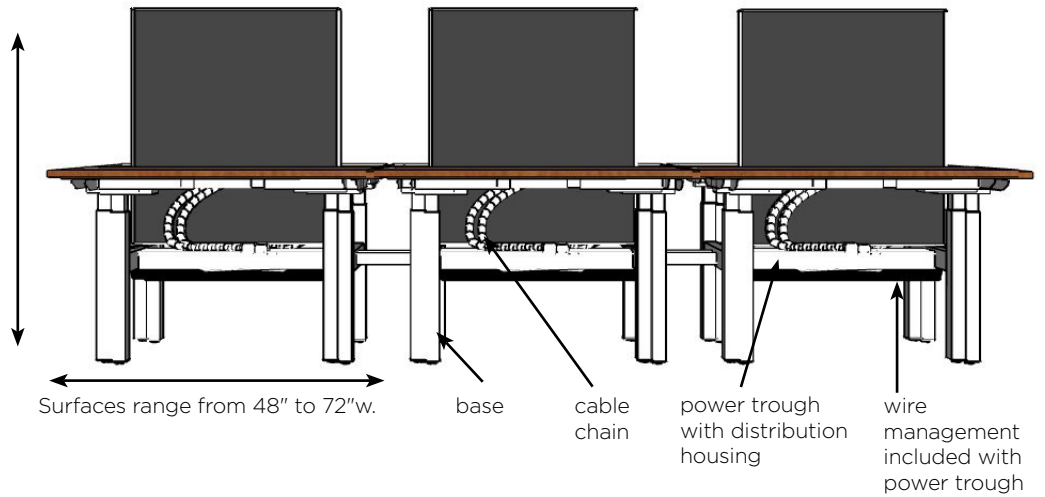
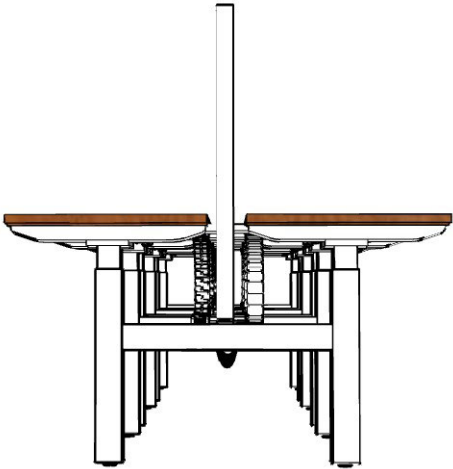

Back-to-Back with Table Mounted Dividers

Divider measures 44.5" h above finished floor when installed.
Dividers move with table.

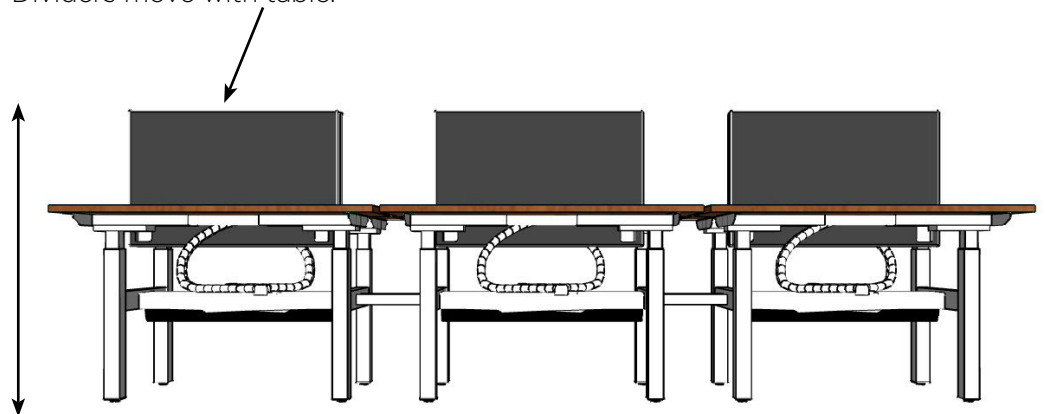
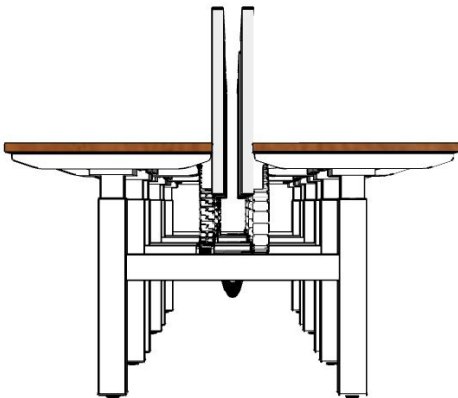

WORKSURFACE KITS

All single sided and back-to-back worksurfaces come as a kit. Each kit contains the following: worksurface, under surface wire management, cable chain, and power distribution housing. Duplexes, table-to-table connector, and infeed specified separately.

1" Laminate - Thermally Fused
Option for High Pressure 1-1/16"



without grommet



grommet with access door

Single Sided

24" or 30" deep

(worksurfaces are nominal dimensions)

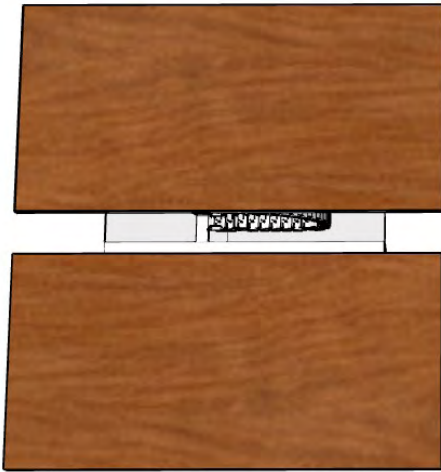

without grommet

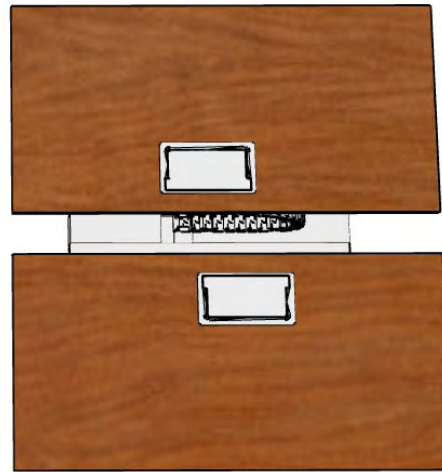

grommet with access door

Back-to-Back

24" or 30" deep

(worksurfaces are nominal dimensions)

Laminate Options

www.globalfurnituregroup.com/us/resources/finishes

Grommet with Access Door Options (upcharges apply)

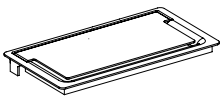

standard access door

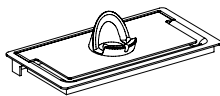

access door with device holder

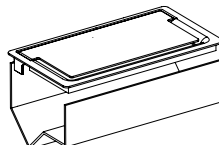

access door with cable tray

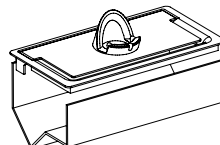

access door with cable tray + device holder

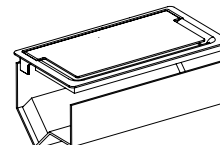

access door with cable tray + power bar

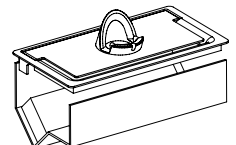

access door with cable tray, power bar + device holder

HEIGHT ADJUSTABLE BASE

Finishes: Black, Designer White, Tungsten

Standard 2-stage height adjustment range of 27.5" - 45.5"

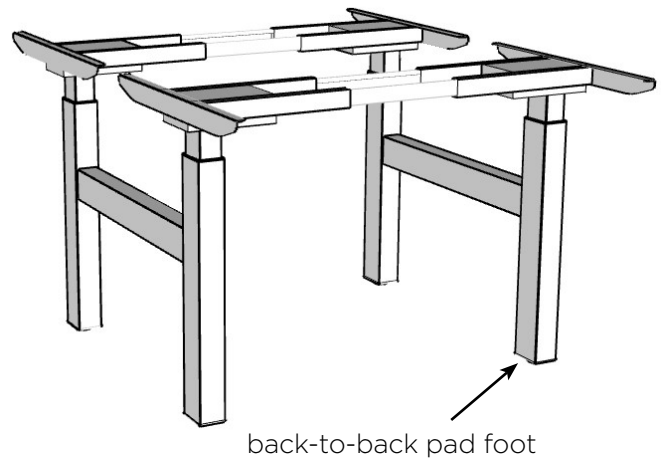
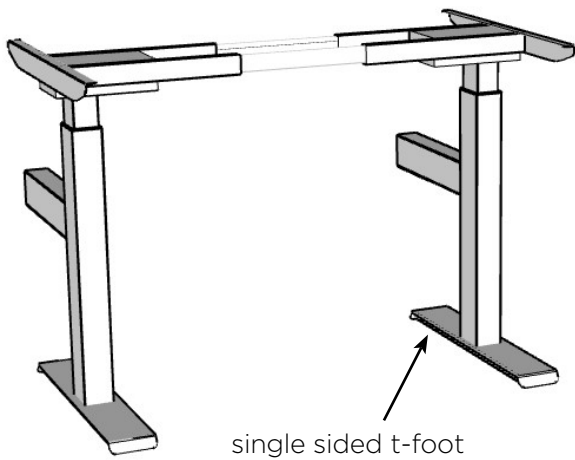

Extended 3-stage height adjustment range of 22.6" - 48.8"

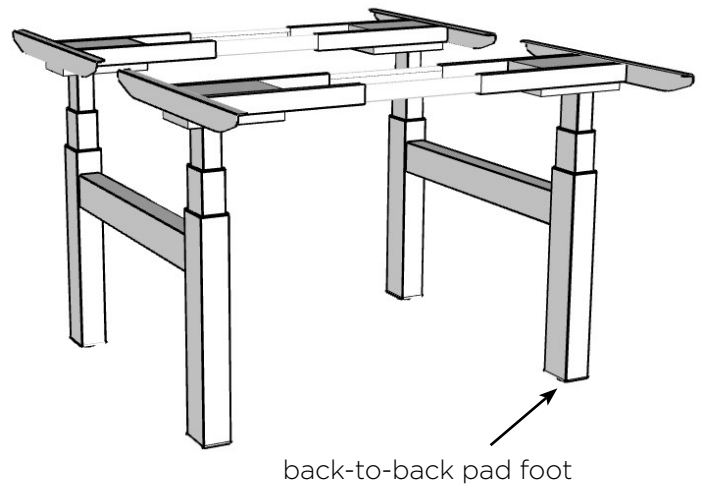
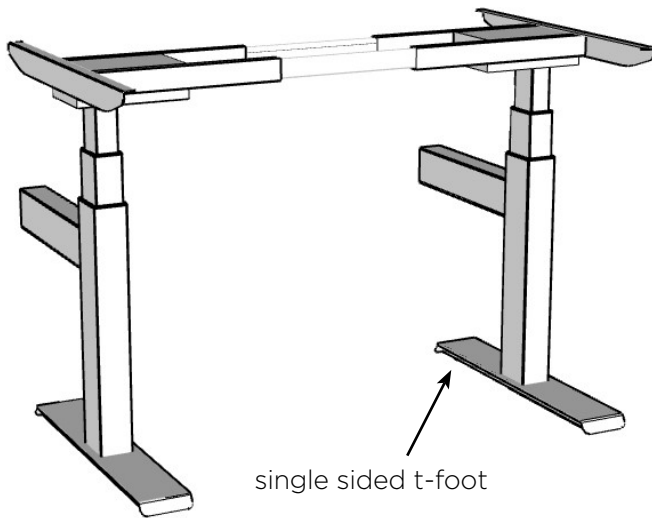

Base Options

Hand Controls

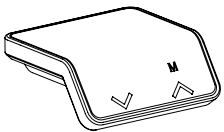

standard

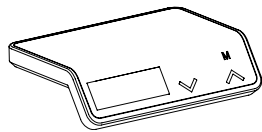

digital readout
(upcharge applies)

Noise Reduction

Industry leading operating sound level of 55dB is standard. Optional **whisper quiet** sound insulation reduces operating sound level to 38dB (upcharge applies).

DIVIDERS

Both single sided and back-to-back dividers measure 54" from above finished floor when installed.

Divider Materials



fabric
(tackable)



glass
(tempered)

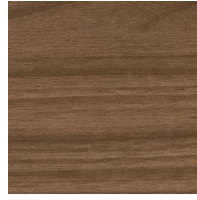

laminate



laminate framed
(whiteboard or magnetic
whiteboard) - upcharge
applies

Single Sided

48" - 72"W

21.5"H



fabric framed



laminate framed



laminate frameless

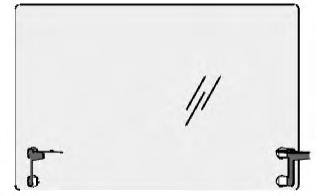

glass

Back-to-Back

48" - 72"W

37.2"H

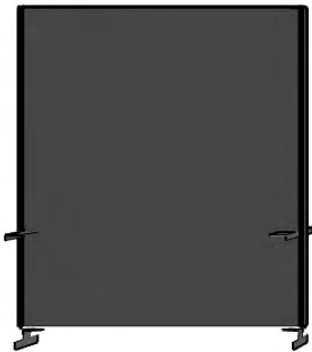

fabric framed

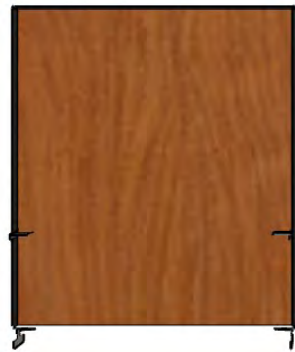

laminate framed



laminate frameless

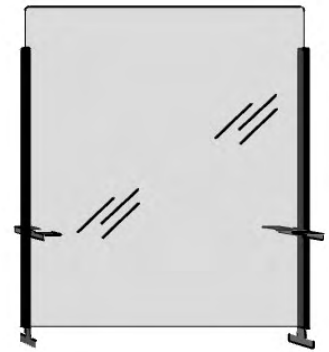

glass

ELECTRIC

4-2-2 Wiring System, 8-Wire Shared Neutral
2+2 (2 Dedicated, 2 Utility Circuits)

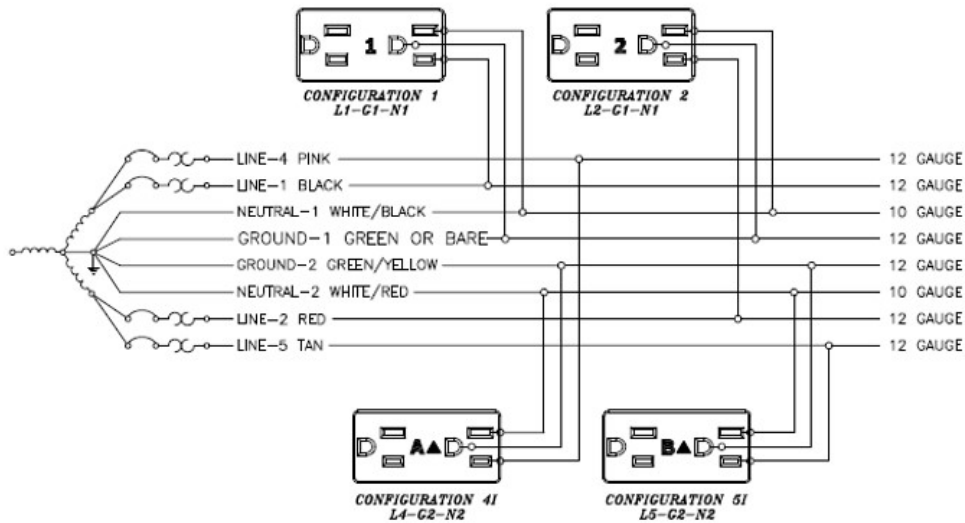

Wiring Diagram Label - Green

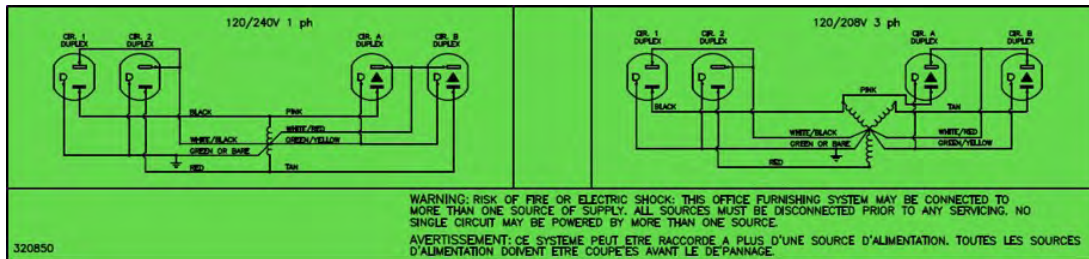

Chicago

- Special request. You can request the special [here](#). Application drawing needed.

New York City

- Specify NY infeed. All other electrical gets specified standard.

California, Title 24

- Controlled circuit duplexes are in the specification tools for all (4) circuits. Specify all other electrical standard.
- Electrical contractor must install proper control devices (occupancy sensor) that will turn off power to controlled circuit duplexes.

ELECTRONIC LIBRARY

GLB - Global Furniture Group
GCU - Global Desking and Tables - USA
Benching
FreeFit Benching
Worksurfaces
Bases
Dividers
Electrical
Accessories/Wire Management

STEP 1

Configuration Options - single sided or back-to-back

GLB - Global Furniture Group
GCU - Global Desking and Tables - USA
Benching
FreeFit Benching
Worksurfaces
Back To Back or Single Sided
With Out Grommet
With Grommet
48" Deep
60" Deep
Back To Back or Single Sided
With Out Grommet
With Grommet
48" Deep
60" Deep

Back-to-Back Surfaces

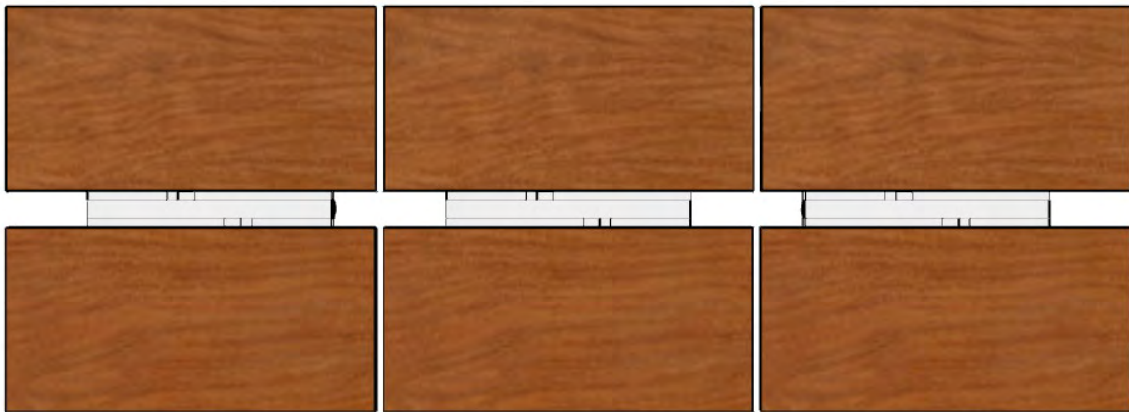

Worksurface kits include: worksurface, wire manager, cable chain, and power trough.

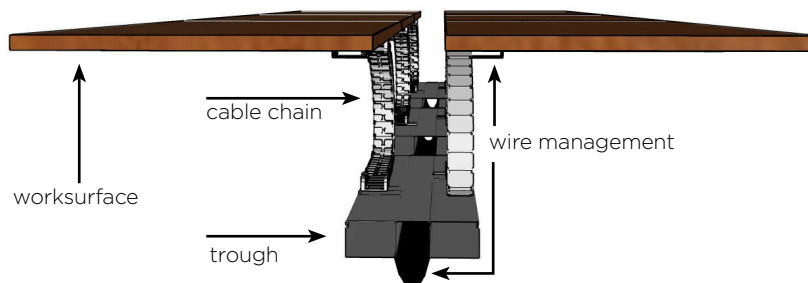

STEP 2

Bases

GLB - Global Furniture Group
GCU - Global Desking and Tables - USA
Benching
FreeFit Benching
Worksurfaces

Bases

Back To Back

2 stage

3 stage

Single Sided

2 stage

3 stage

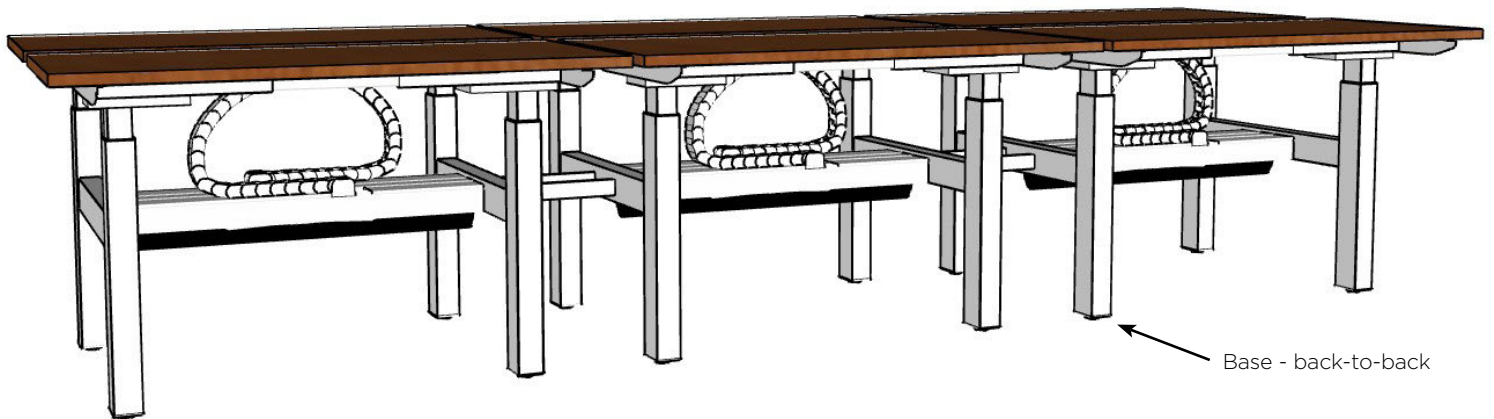
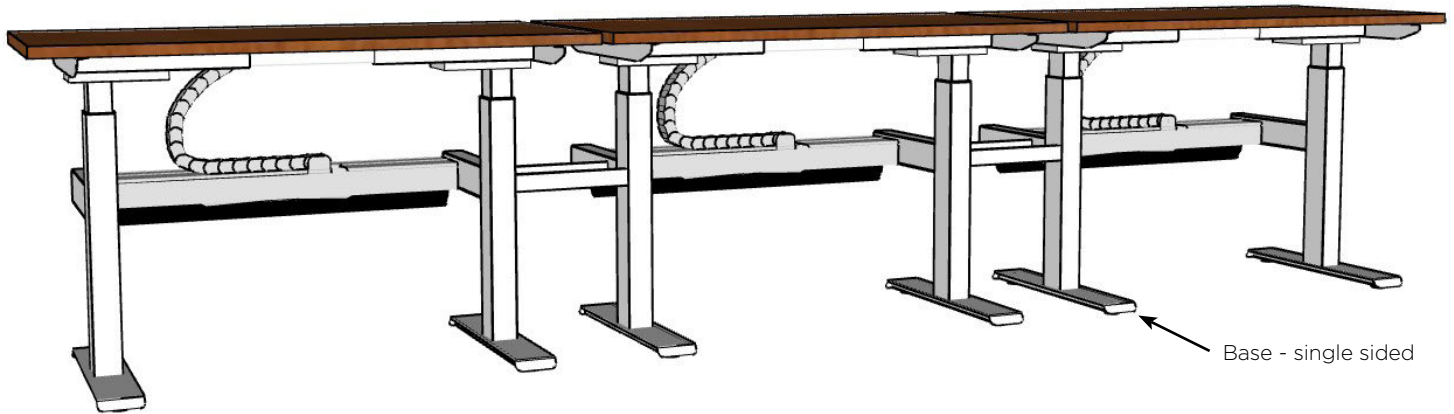

One base available on all worksurface sizes. When optioning out the base in your quote system you will be able to pick the width of the base that correlates with the worksurface size.

STEP 3

Dividers

GLB - Global Furniture Group
GCU - Global Desking and Tables - USA
Benching
FreeFit Benching
Worksurfaces
Bases

Dividers

Back To Back
Fabric
Laminate
Glass
Single Sided
Fabric
Laminate
Glass

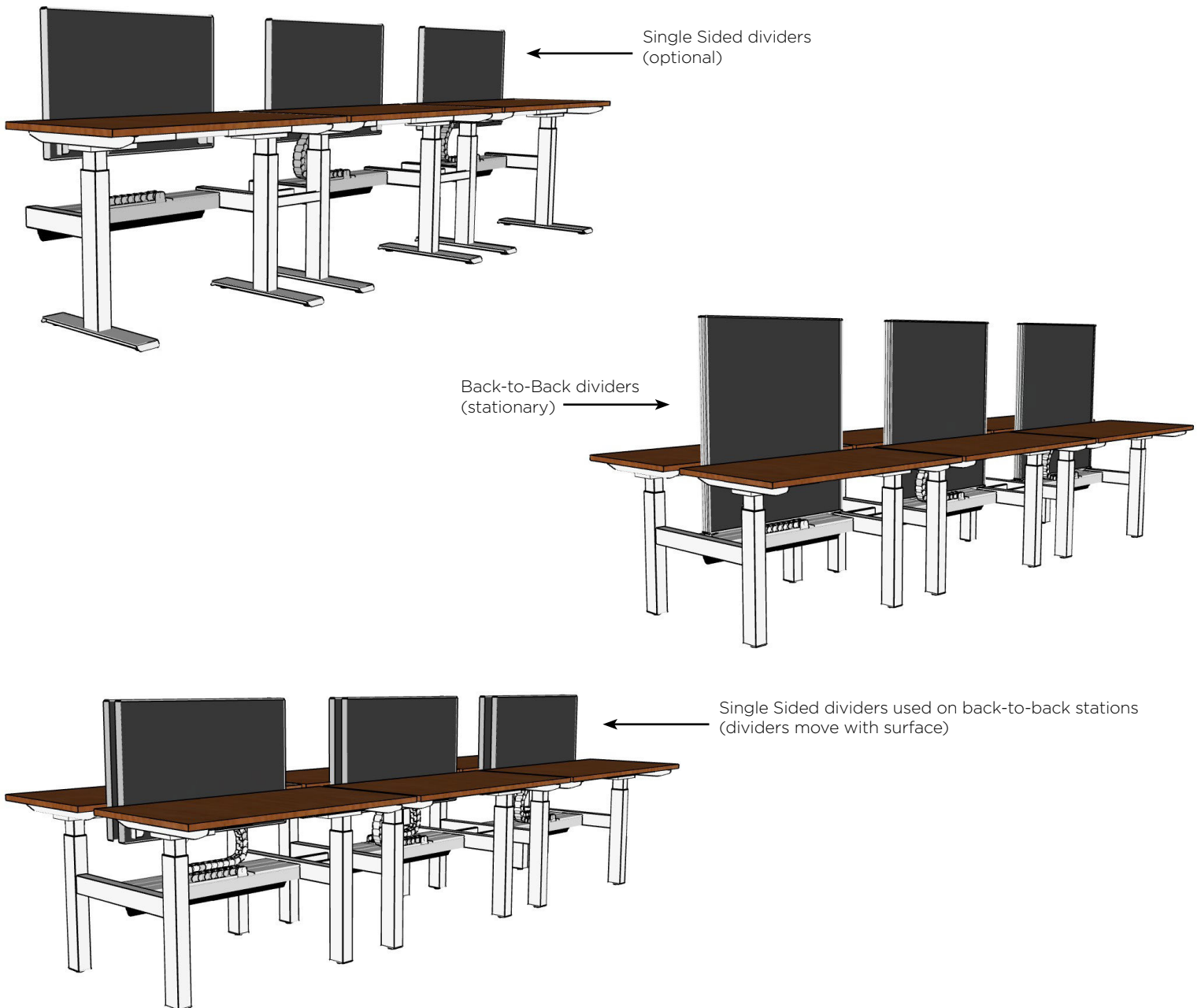

STEP 4

Electrical

GLB - Global Furniture Group
GCU - Global Desking and Tables - USA
Benching
FreeFit Benching
Worksurfaces
Bases
Dividers
Electrical
Table-to-Table Connector (jumper)
Duplex Receptacles
Power Entry - Floor/Ceiling

Duplexes

48"-72" wide worksurfaces can accept 2 duplexes per user

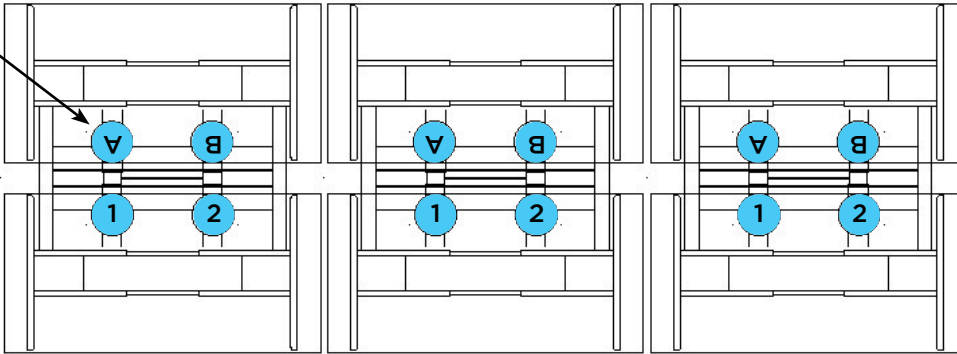
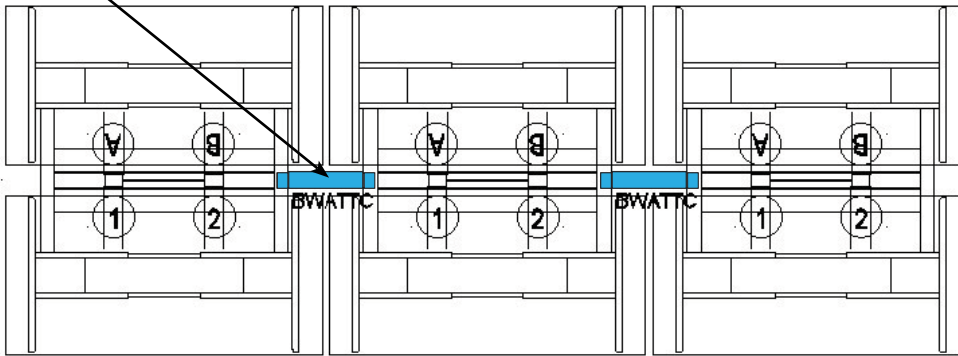
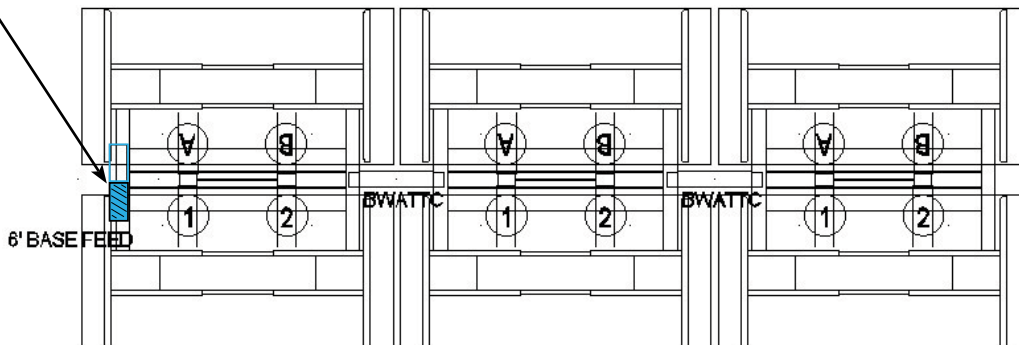

Table-to-Table Connector (jumper)



Infeed - Basefeed or Ceiling Feed



STEP 5

Accessories (optional)

GLB - Global Furniture Group
 GCU - Global Desking and Tables - USA
 Benching
 FreeFit Benching
 Worksurfaces
 Bases
 Dividers
 Electrical

Accessories/Wire Management

Power Bar
 CPU Holder
 Wire Management

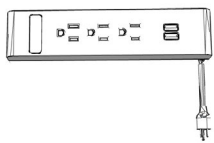

Power Bar

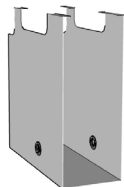

CPU Holder



Cable Chain

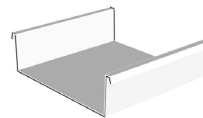

Under Surface
Wire Management

STEP 6

Storage (optional)

GLB - Global Furniture Group
 GCU - Global Desking and Tables - USA
 Benching
 FreeFit Benching
 Worksurfaces
 Bases
 Dividers
 Electrical
 Accessories/Wire Management

Storage

24" Deep
 30" Deep
 36" Deep
 12" Wide
 18" Wide
 Right
 Left

Pantry Storage

Can be specified at the ends and middle of stations

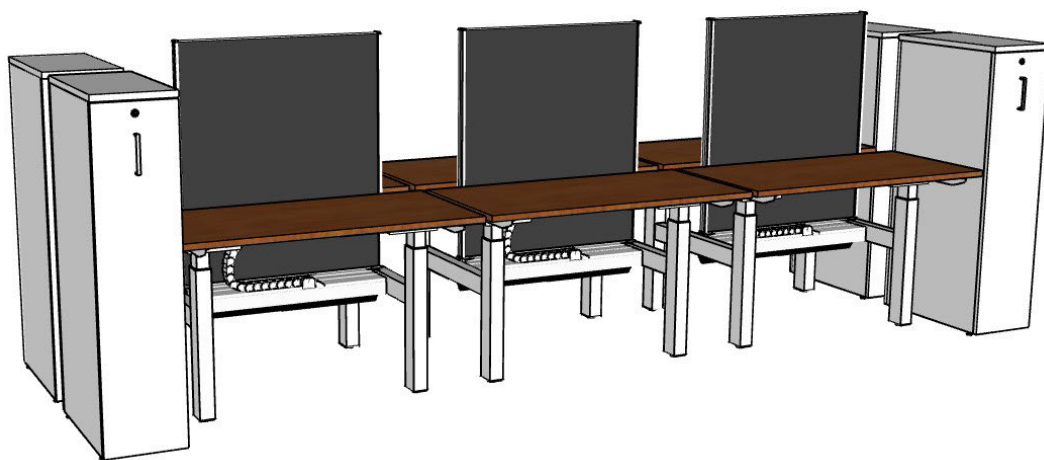

When specifying pantry storage in between stations, all electrical will be specified the same except for the table-to-table connector (jumper).

Extended Table to Table Connector (jumper)

- BWAETTC12 is used when a 12" w pantry tower separates two stations
- BWAETTC18 is used when a 18" w pantry tower separates two stations
- BWAETTC24 is used when a (2) 12" w pantry tower separates two stations
- BWAETTC36 is used when a (2) 18" w pantry tower separates two stations
- BWAETTC48 is used when storage up to 48" w separates two stations.

Mobile Pedestal Metal

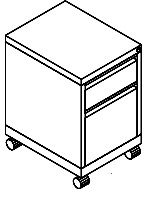

1900P - 23.125"h

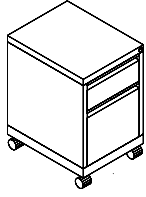

9300P - 23.875"h

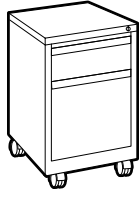

GMP - 22"H

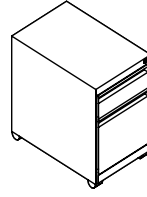

1200P - 22.11"H

Fixed Lateral or Storage, Half Height Metal

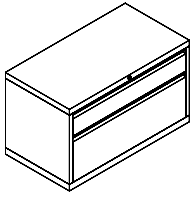

1900 - 21.25"H

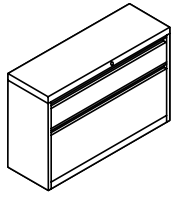
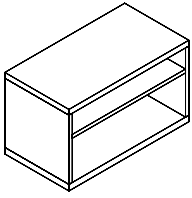

1200 - 21.25"H

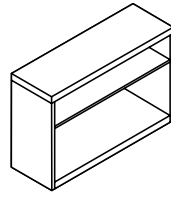

Fixed Storage Metal
cannot nest under surface*

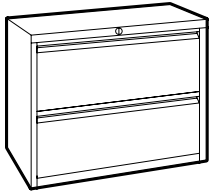

1900P

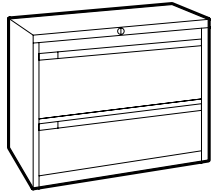

9300P

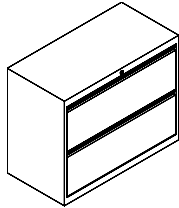

1200P

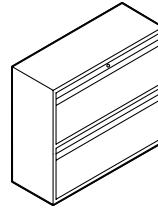

9100P

*Storage 25" or lower can nest under surface.

Mobile Pedestal Laminate

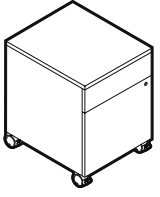

Zira - 22"h

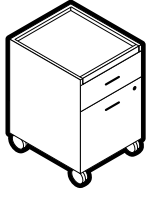

Sidebar - 25"h

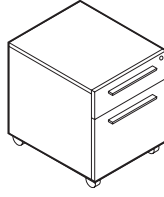

Princeton - 20.5"H

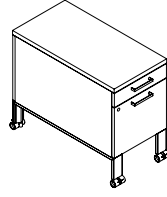

Bridges II - 21" or 25"H

Low Storage and Credenzas Laminate

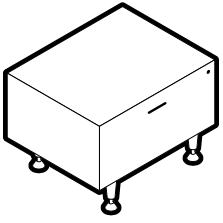

Sidebar - 22.85"H

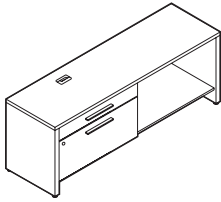

Princeton - 23"H

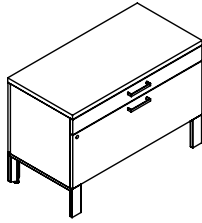

Bridges II - 21" or 25"H

Storage and Credenzas Laminate
cannot nest under surface*

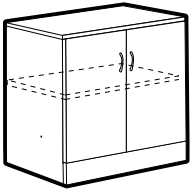

Zira

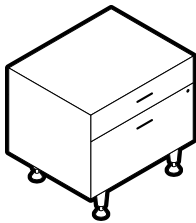

Sidebar

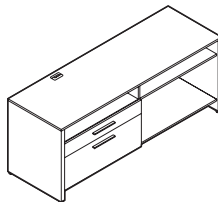

Princeton

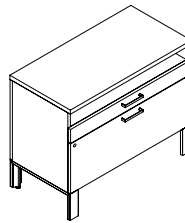

Bridges II

*Storage 25" or lower can nest under surface.

Global US Headquarters/Distribution Center

17 West Stow Road, P.O. Box 562
Marlton, New Jersey U.S.A. 08053
T (856) 596-3390
T (800) 220-1900
F (856) 596-5684

Showrooms

Atlanta

10 10th Street
Suite 150
Atlanta, GA 30309
T (404) 879-0998
F (404) 879-9995

Boston

One Harbor Street
Suite 104
Boston, MA 02210
T (617) 406-5435
F (617) 406-5438

Chicago

The Merchandise Mart
222 Merchandise Mart Plaza
10th Floor, Suite 1035
Chicago, IL 60654
T (312) 755-0843
F (312) 755-0837

Detroit Area

25925 Telegraph Road
Suite 145
Southfield, MI 48034
T (248) 357-7211
F (248) 357-7241

Ft. Lauderdale

Las Olas City Centre
401 East Las Olas Blvd.
Suite 230
Ft. Lauderdale, FL 33301
T (954) 763-2684
T (800) 331-0529
T (954) 763-6870

New York City

386 Park Avenue South
7th floor
New York, NY 10016
T (212) 545-9900
T (888) 315-1301
F (212) 545-5826

Philadelphia

1735 Market Street
38th Floor
Philadelphia PA, 19103
(215) 861-0963

New Jersey (Southern)

119 Greentree Road
Marlton, NJ 08053
T (856) 596-3390
T (800) 220-1900
F (856) 596-4472

Phoenix

4675 E Cotton Center Blvd.
Suite 165
Phoenix, AZ 85040
T (602) 426-0666
T (602) 426-0777
F (602) 426-1148

St. Louis

5 Document Drive
St. Louis, MO 63114
T (314) 432-4463
F (314) 432-4471

Washington, DC

1130 Connecticut Avenue
10th Floor, Suite 1000
Washington, DC 20036
T (202) 659-0230
T (202) 659-0236
F (202) 659-0306

Distribution Centers

Atlanta Area

2124 Evergreen Blvd.
Duluth, GA 30096
T (678) 602-4130
T (800) 220-7328
F (678) 602-4136

Baltimore Area

Troy Hill Corporate Center
7030 Troy Hill Drive
Elkridge, MD 21075
T (410) 379-8021
T (800) 863-7300
F (301) 362-9444

Boston Area

19 Connector Road
Unit 1
Andover, MA 01810
T (978) 470-8463
T (800) 876-8980
F (978) 470-8920

Chicago Area

1879 Internationale Blvd.
Glendale Heights, IL 60139
T (630) 681-2818
T (800) 866-6497
F (630) 681-1631

Cincinnati Area

8712 LeSaint Drive
Fairfield, OH 45014
T (513) 777-0009
T (800) 552-3375
F (513) 777-5863

Dallas Area

2025 West Beltline Road
#100
Carrollton, TX 75006
T (972) 236-1366
T (800) 929-2936
F (972) 236-1372

Denver Area

16401 East 33rd Drive
Suite 50
Aurora, CO 80011
T (303) 340-1617
T (800) 275-6655
F (303) 340-1657

Ft. Lauderdale Area

560 Sawgrass Corp. Pkwy
Sunrise, FL 33325
T (954) 846-8888
T (800) 331-0529
F (954) 846-8110

Houston Area

7865 Northcourt Road
Building D, Suite 200
Houston, TX 77040
T (713) 695-5777
T (800) 935-6468
F (713) 695-5778

Los Angeles Area

12320 Bloomfield Avenue
Unit A
Santa Fe Springs, CA 90670
T (562) 484-9686
T (800) 640-0301
F (562) 484-9685

Minneapolis Area

2000 Freeway Boulevard
Brooklyn Center, MN 55430
T (763) 560-8196
T (800) 829-2153
F (763) 560-2098

New Orleans Area

901 South Labarre Road
Suite 201
Metairie, LA 70001
T (504) 834-6228
T (800) 275-0663
F (504) 835-9638

Pittsburgh Area

380 Leetsdale Industrial Dr.
Leetsdale, PA 15056
T (724) 385-1200
T (800) 942-9999
F (724) 385-1207

San Antonio Area

6950 Alamo Downs Pkwy
Suite 100
San Antonio, TX 78238
T (210) 684-8450
T (800) 683-4000
F (210) 684-3700

San Francisco Area

44091 Nobel Drive
Fremont, CA 94538
T (510) 897-4150
T (888) 418-4800
F (510) 897-4156

Seattle Area

Oakesdale Commerce Ctr.
820 Southwest 34th Street
Building W7, Suite A
Renton, WA 98057
T (425) 291-9282
T (888) 218-2600
F (425) 291-9287

Kansas City Area

11617 West 81st Street
Lenexa, KS 66214
T (913) 310-9963
T (800) 796-0770
F (913) 310-9976

Tampa Area

10351 Windhorst Road
Tampa, FL 33619
T (813) 621-6272
T (877) 707-3966
F (813) 621-7958



globalfurnituregroup.com

