

## Zira Desking

Effective January 2017



# DESIGN GUIDE desking + tables



**Table of Contents**

Product Maps .....2-4

Worksurfaces: Desks .....5

Worksurfaces: Extended Corner Islands .....5

Worksurfaces: Extended Corners, Returns, Bridges, Shells .....6

Worksurfaces: Grommets, Modesty Panels, Power Blocks.....7

Storage Modules .....8-9

Collator Positions ..... 10, 12

Glazing .....10, 12

Tabletops, Hutches, Overhead Storage, End Shelves, & Bookcases.....11-12

Wall Mounted Tackboards.....13

## WORKSURFACES

### Desks

Bow

Straight

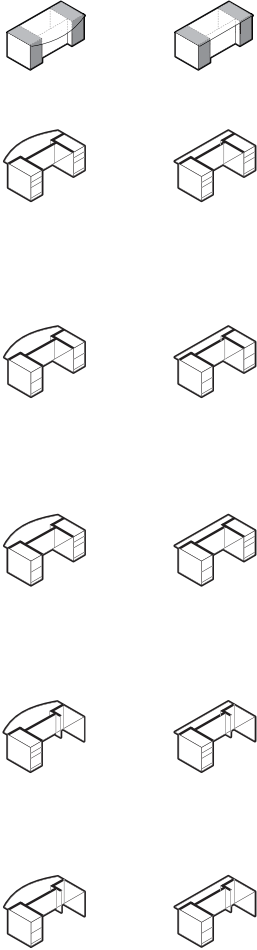

### Credenzas

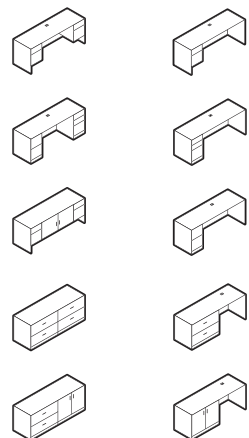

### Extended Corner Desks

Freestanding & Faux Pedestal

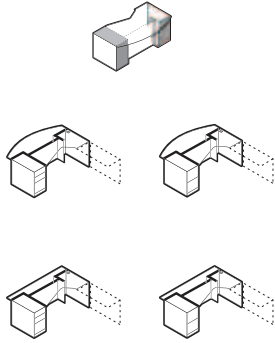

### Extended Corner Islands

"P" Top Delta Top

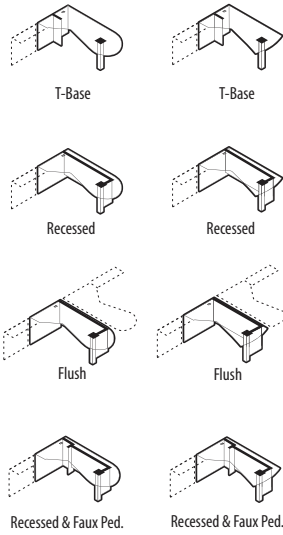

### Extended Corners

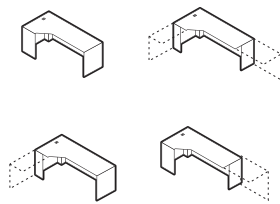

### 5 Sided Corner



### Returns

Flush Space Saver

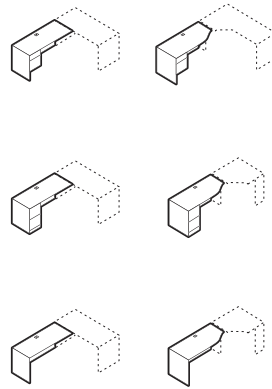

### Bridges

Flush Space Saver

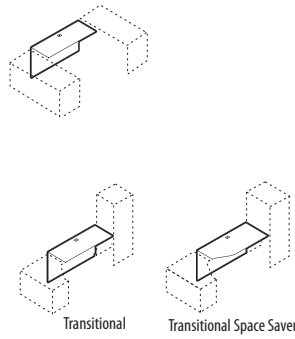

### Tables & Connectables

Flush Space Saver

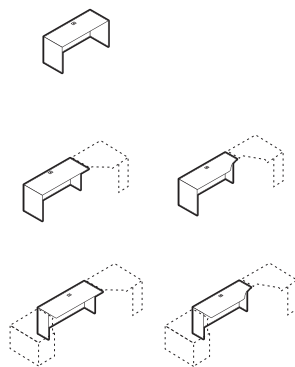

### Shells

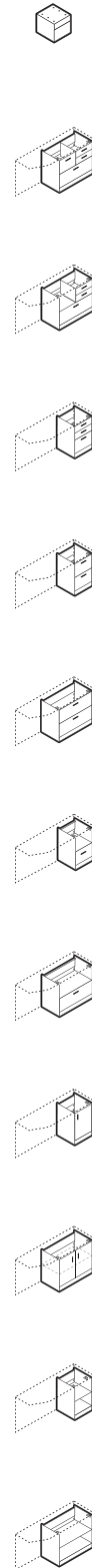

### Islands

"D" Island

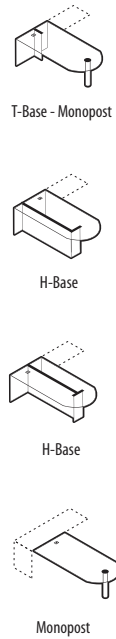

### "P" Island

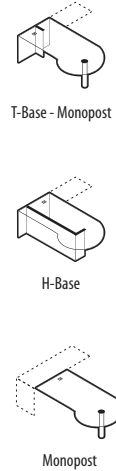

### Radius Spanner Islands



# STORAGE MODULES

|         |               | Closed  |        |        |        |        |              | Cavity |                | Open |        |        |        |        |
|---------|---------------|---------|--------|--------|--------|--------|--------------|--------|----------------|------|--------|--------|--------|--------|
|         |               | Shelves | 1 File | 2 File | 3 File | 4 File | Vertical Dwr | 2 File | 2 Box / 1 File | Open | 1 File | 2 File | 3 File | 4 File |
| Storage | 84" ht.       |         |        |        |        |        |              |        |                |      |        |        |        |        |
|         | 71½" ht.      |         |        |        |        |        |              |        |                |      |        |        |        |        |
|         | 65" ht.       |         |        |        |        |        |              |        |                |      |        |        |        |        |
|         | 52½" ht.      |         |        |        |        |        |              |        |                |      |        |        |        |        |
|         | 41" ht.       |         |        |        |        |        |              |        |                |      |        |        |        |        |
| 29" ht. | Mixed Storage |         |        |        |        |        |              |        |                |      |        |        |        |        |

|                            |          | Closed     |             |        |        |        |                | Cavity |                | Open        |        |        |        |                |
|----------------------------|----------|------------|-------------|--------|--------|--------|----------------|--------|----------------|-------------|--------|--------|--------|----------------|
|                            |          | Full width | Half & half | 2 File | 3 File | 4 File | 2 Box / 1 File | 2 File | 2 Box / 1 File | Half & half | 2 File | 3 File | 4 File | 2 Box / 1 File |
| Wardrobe & Personal Towers | 84" ht.  |            |             |        |        |        |                |        |                |             |        |        |        |                |
|                            | 71½" ht. |            |             |        |        |        |                |        |                |             |        |        |        |                |
|                            | 65" ht.  |            |             |        |        |        |                |        |                |             |        |        |        |                |

|            |  | 29" ht. | 41" ht. | 71½" ht. | 84" ht. | 1 Box / 2 File | 2 File | 2 Box / 1 File |
|------------|--|---------|---------|----------|---------|----------------|--------|----------------|
| PC support |  |         |         |          |         |                |        |                |
|            |  |         |         |          |         |                |        |                |

# TABLE TOPS, HUTCHES, OVERHEAD STORAGE, END SHELVES & BOOKCASES

|          | Table Top Book Cases |        |      | Hutches |      | Overhead Storage                 |      | End Shelves | Table Top End Shelves | Bookcases | Accessories  |
|----------|----------------------|--------|------|---------|------|----------------------------------|------|-------------|-----------------------|-----------|--|
|          | Closed               | Cavity | Open | Cavity  | Open | Closed                           | Open | Open        | Open                  | Open      |  |
| 84" ht.  |                      |        |      |         |      |                                  |      |             |                       |           | <b>Horizontal Pigeon Hole Storage</b><br><br>      |
| 71½" ht. |                      |        |      |         |      |                                  |      |             |                       |           | <b>Vertical Pigeon Hole Storage</b><br><br><br>    |
| 65" ht.  |                      |        |      |         |      |                                  |      |             |                       |           | <b>20"/24" Deep Full Leg</b><br><br>               |
| 52½" ht. |                      |        |      |         |      | <b>Transitional Pigeon-Holes</b> |      |             |                       |           | <b>Black Pencil Drawer w/Roller Slides</b><br><br> |
| 41" ht.  |                      |        |      |         |      |                                  |      |             |                       |           | <b>Pull-out Keyboard Tray</b><br>                  |
| 29" ht.  |                      |        |      |         |      |                                  |      |             |                       |           | <b>Mobile CPU Skateboard</b><br>                   |
|          |                      |        |      |         |      |                                  |      |             |                       |           | <b>Collators</b><br><br>                           |

# WORKSURFACES

## Desks / Extended Corner Desks - available width: 60", 66", 72" 84"

### Modesty Treatments

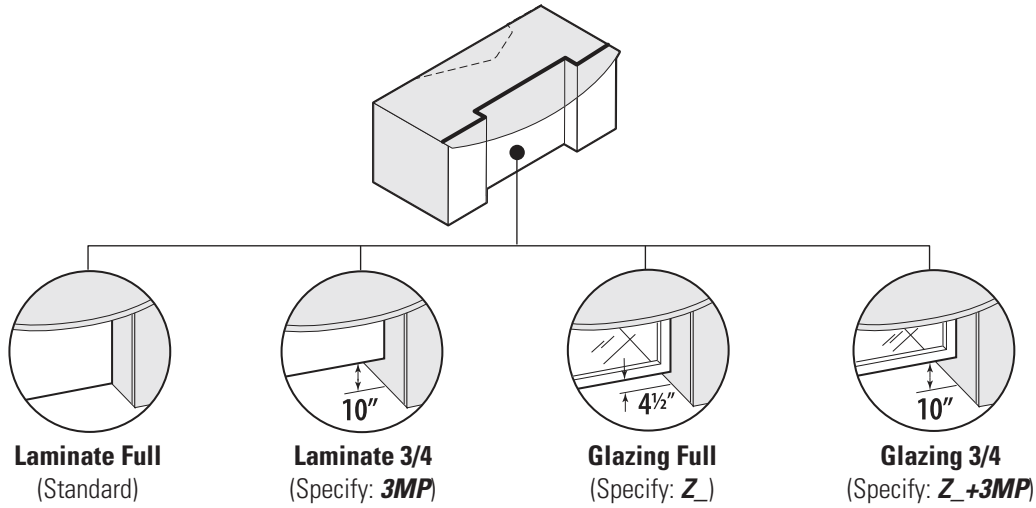

### Overhang Dimensions

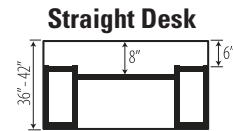
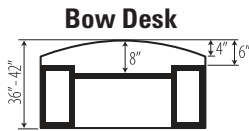

## Extended Corner Islands - available width: 60", 66", 72" 84"

### Modesty Treatments

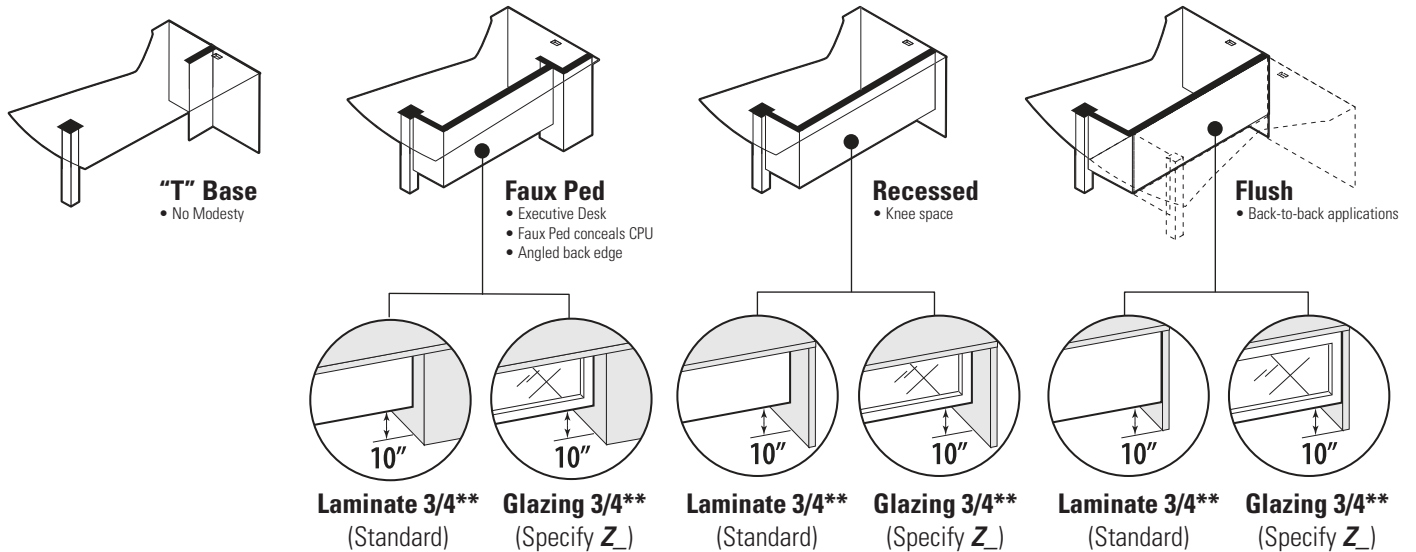

\*\* Full modesty not available

### Overhang Dimensions

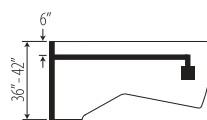
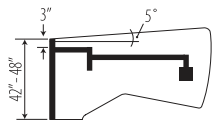
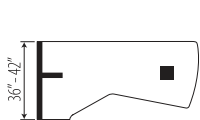

# WORKSURFACES

## Extended Corners - available widths: 60", 66", 72", 84"

### Modesty Treatments

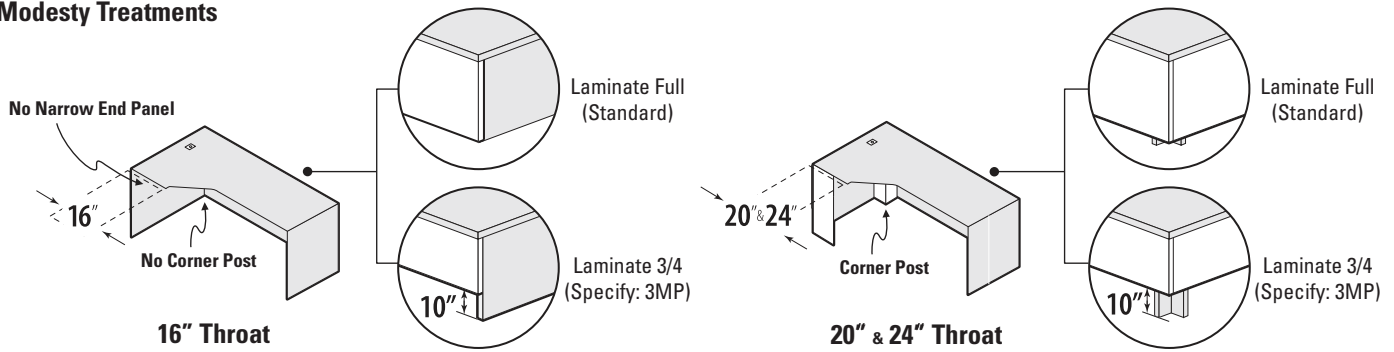

## Returns - available width: 36", 42", 48", 54", 60", 66", 72"

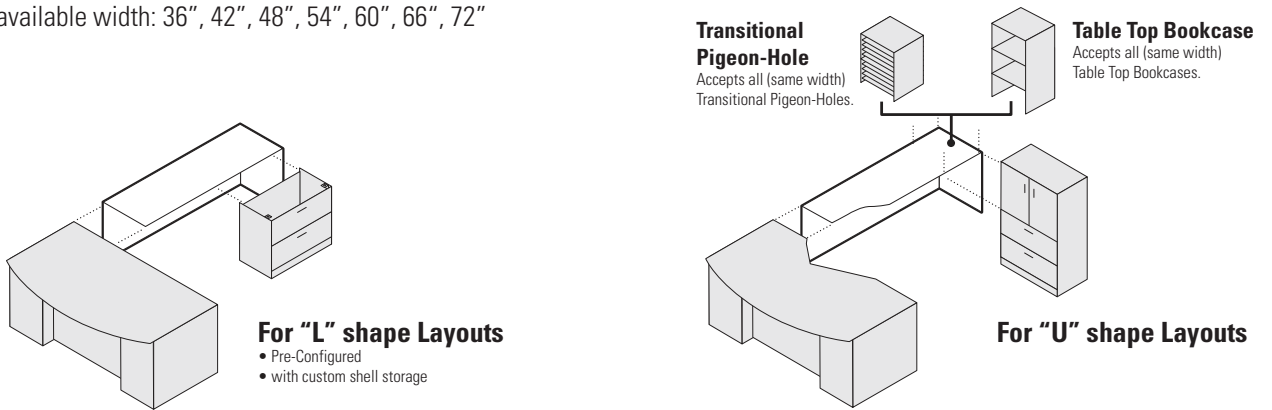

## Bridges - available width: 42", 48"

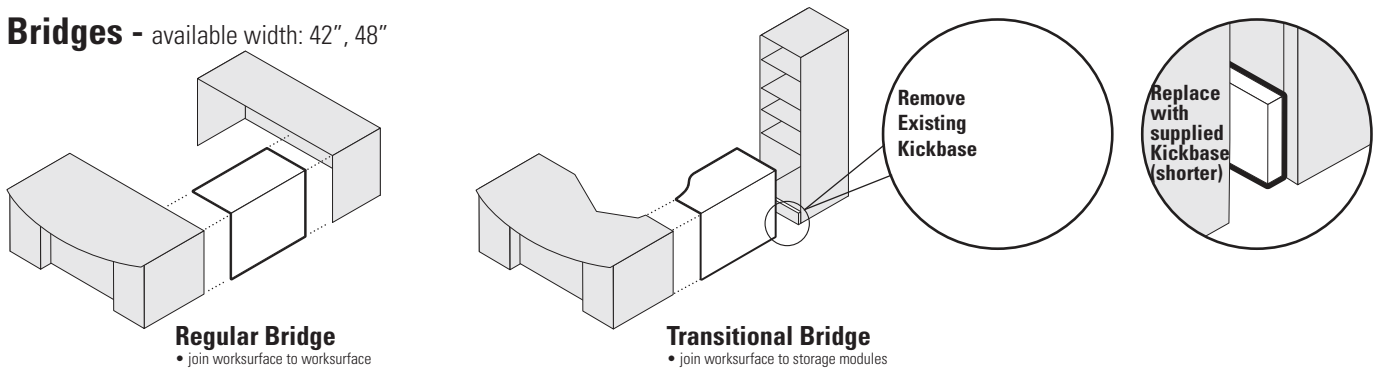

## Shells - available width: 12", 15", 16", 18", 21", 30", 36"

For Extended Corners, Space Saver Returns and Connectables

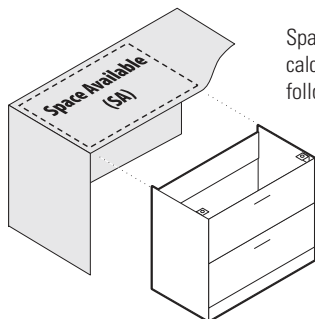

Space Available can be calculated with the following formulas:

### Space Saver Returns

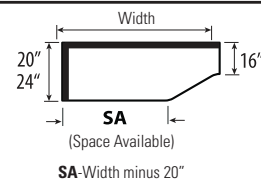

### Space Saver Connectables

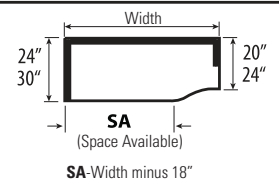

### Extended Corners

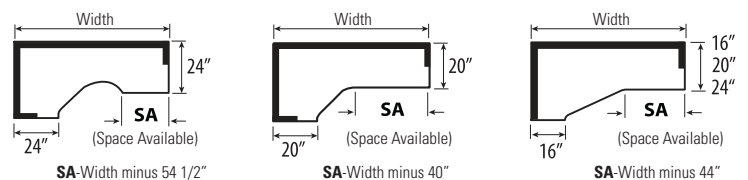

# WORKSURFACES

## Grommets

### Desks

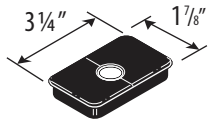

**Bow**

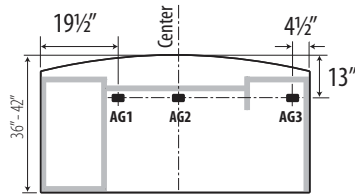

**Straight**

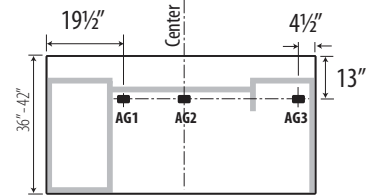

### Modesty Panels

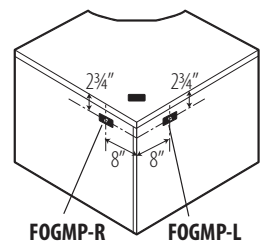
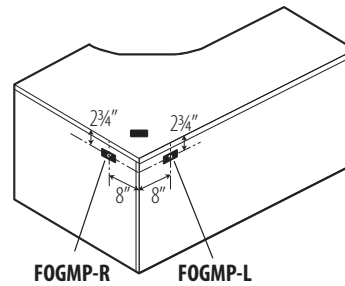
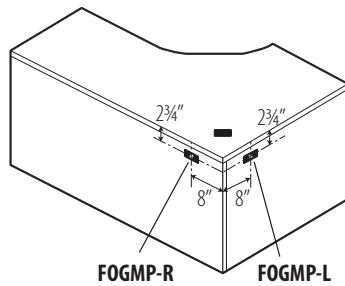

### Power Block

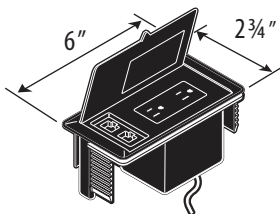

**Bow**

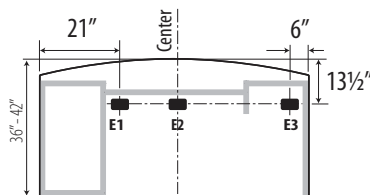

**Straight**

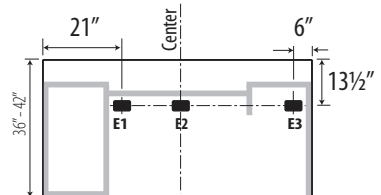



# STORAGE MODULES

CODING LOGIC - e.g. **Z36S2SHN**:

| WIDTH       | DEPTH    | HEIGHT   | CONFIGURATION | STYLE       |
|-------------|----------|----------|---------------|-------------|
|             |          | 2=29"    |               |             |
|             |          | 3=36"    |               |             |
|             |          | 4=41"    |               |             |
|             |          | 5=53"    |               |             |
|             | L=24"    | 6=65"    | SH=Shelving   | N = No Door |
|             | M=20"    | 7=72"    | WA=Wardrobe   | L = Left    |
|             | S=16"    | 8=84"    | 3F=3FILE etc. | R = Right   |
| <b>Z 36</b> | <b>S</b> | <b>2</b> | <b>SH</b>     | <b>N</b>    |

## Storage

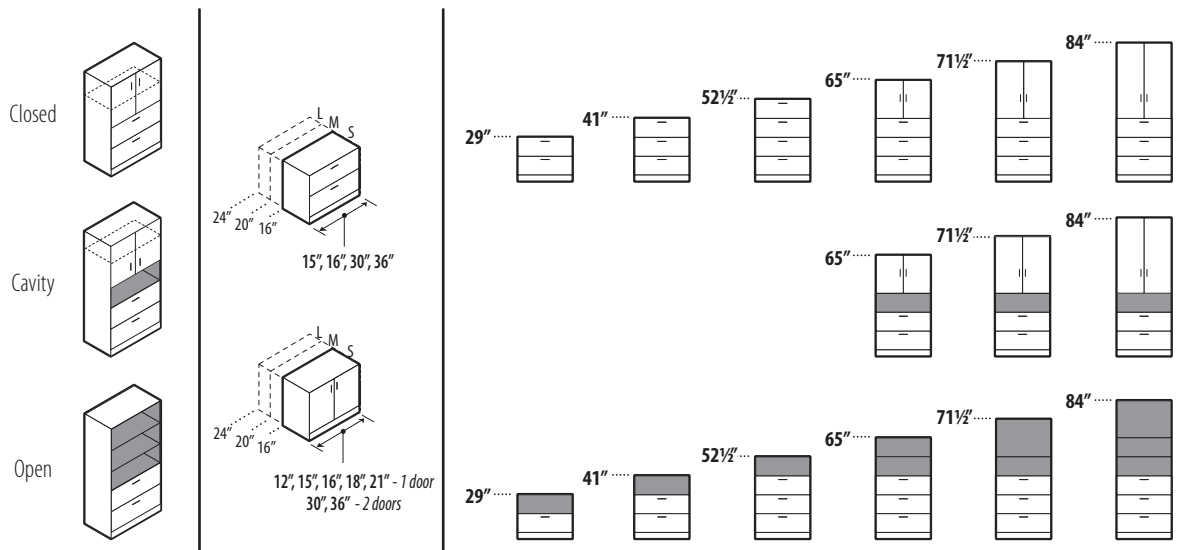

## Wardrobe & Personal Towers

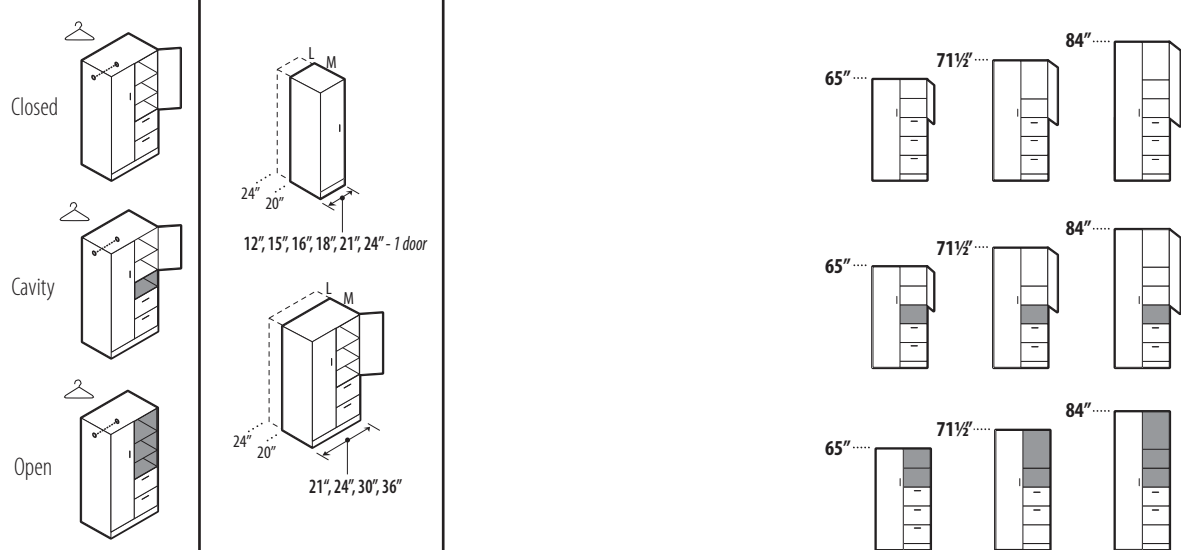

# STORAGE MODULES

## PC Support

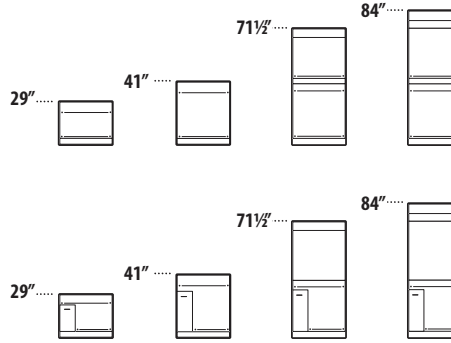
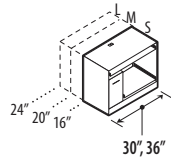
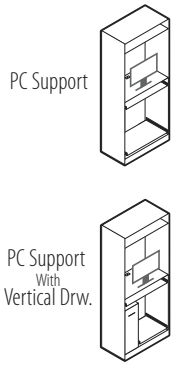

## Vertical Drawers

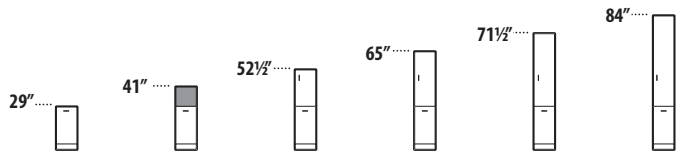
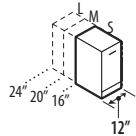
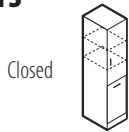

## Drawer & Cavity Positions

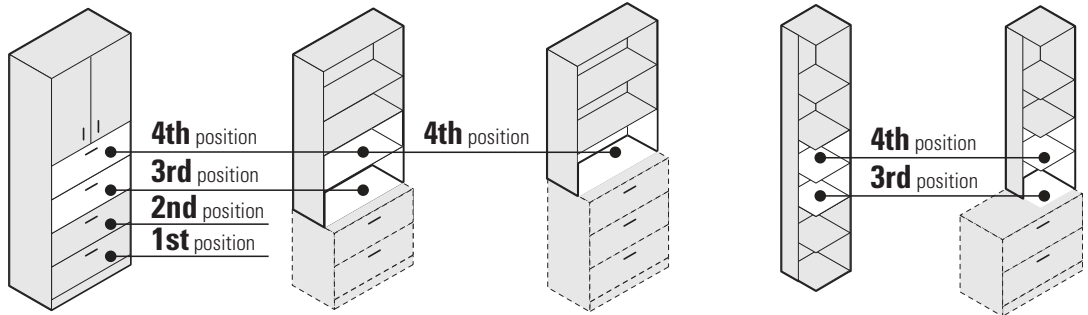

## Box Drawer Option

File drawers can be converted to box/box drawers in any of the four standard positions

- B1** = 2 box drawers on 1st position
- B2** = 2 box drawers on 2nd position
- B3** = 2 box drawers on 3rd position
- B4** = 2 box drawers on 4th position

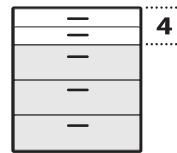
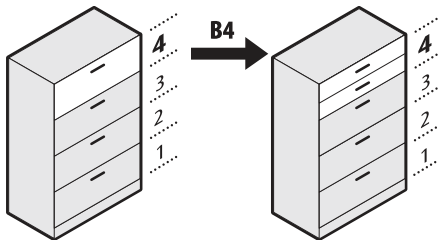

Example  
File drawer converted to 2 box drawers on 4th position

Please specify: Z36L54F - **B4**

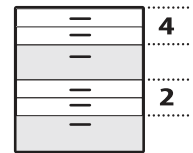

Converting 2 or more drawers please contact customer service.

## Collator Positions

All storage units can be specified with an optional collator on 2<sup>nd</sup>, 3<sup>rd</sup> and/or 4<sup>th</sup> position.

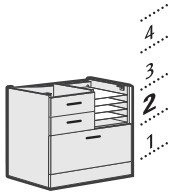

Collator on 2nd position  
Specify: 2K - Black or  
2T - Brushed Cobalt

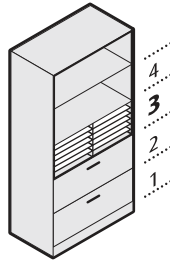

Collator on 3rd position  
Specify: 3K - Black or  
3T - Brushed Cobalt

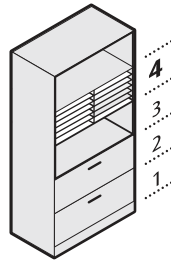

Collator on 4th position  
Specify: 4K - Black or  
4T - Brushed Cobalt

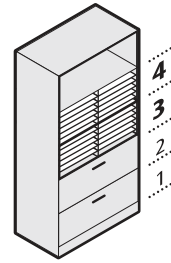

Collator on 3rd & 4th positions  
Specify: 7K - Black or  
7T - Brushed Cobalt

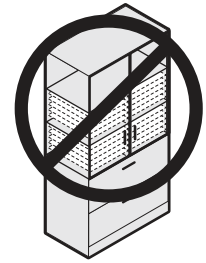

Collators do not fit behind doors

## Glazing

Glazing is available in the following options:

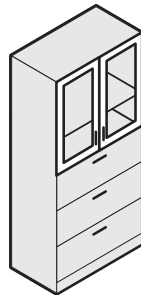

Silver Frame  
Frosted Glazing  
**Z1**

Please specify:  
Z36L73F - **Z1**

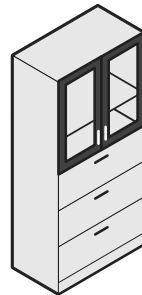

Black Frame  
Frosted Glazing  
**Z2**

Please specify:  
Z36L73F - **Z2**

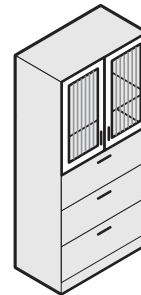

Silver Frame  
Ribbed Glazing  
**Z3**

Please specify:  
Z36L73F - **Z3**

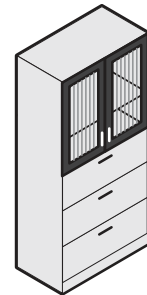

Black Frame  
Ribbed Glazing  
**Z4**

Please specify:  
Z36L73F - **Z4**

# TABLE TOPS, HUTCHES, OVERHEAD STORAGE, END SHELVES & BOOKCASES

## Table Top Bookcase

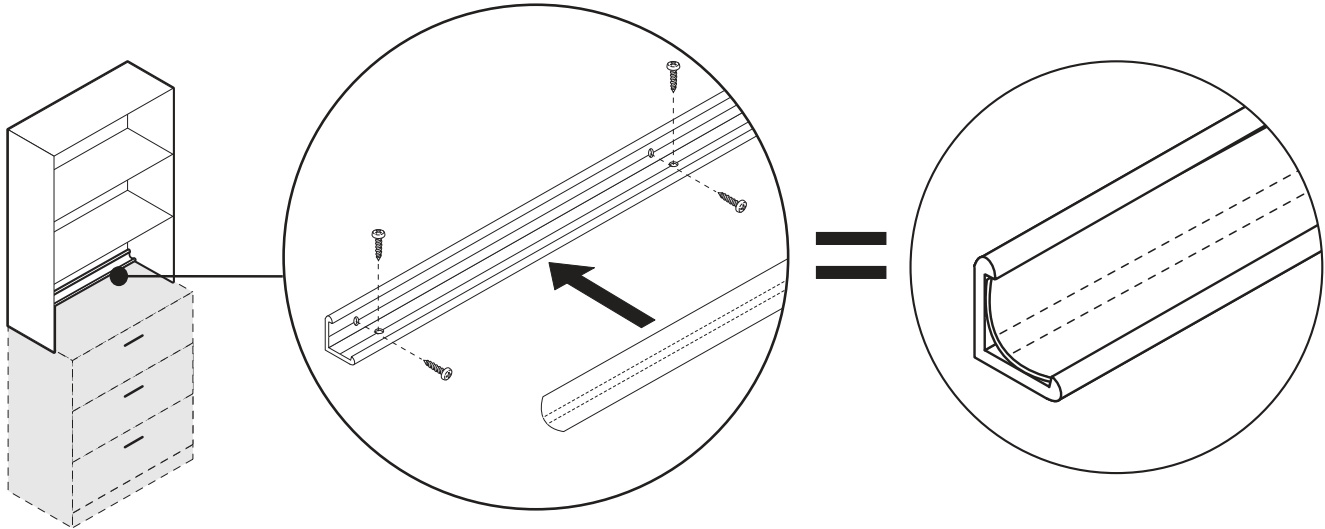

### Hutches

Monitor clearance dimensions

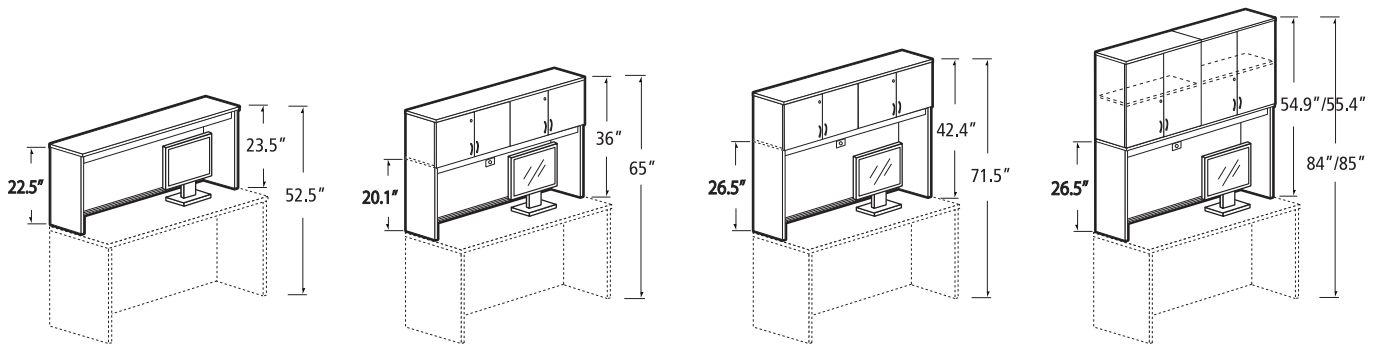

### Height Map

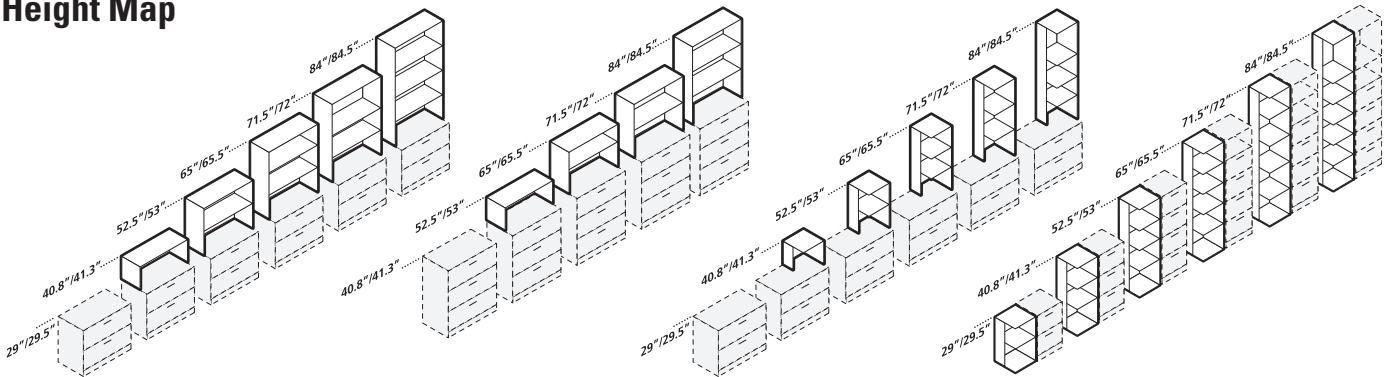

# TABLE TOPS, HUTCHES, OVERHEAD STORAGE, END SHELVES & BOOKCASES

## Drawer & Cavity Positions

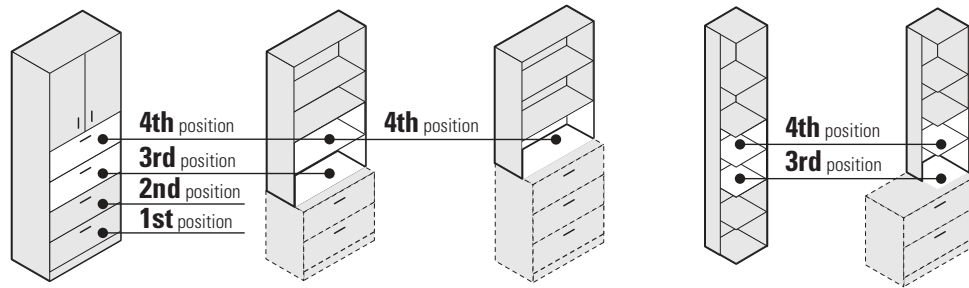

## Collator Positions

For 12" to 21" wide units

Can be specified with an optional collator on 3<sup>rd</sup> and/or 4<sup>th</sup> position.

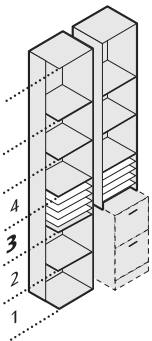

Collator on 3rd position  
Specify: 3K - Black or  
3T - Brushed Cobalt

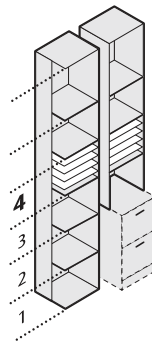

Collator on 4th position  
Specify: 4K - Black or  
4T - Brushed Cobalt

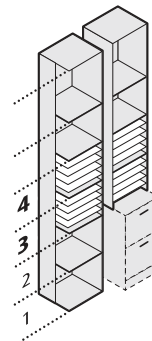

Collator on 3rd & 4th position  
Specify: 7K - Black or  
7T - Brushed Cobalt

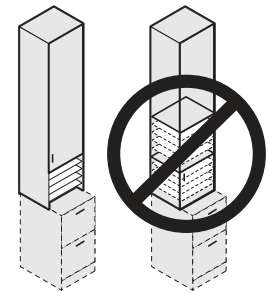

Collators do not fit behind door

## Glazing

Glazing is available in the following options:

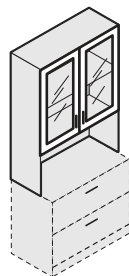

Silver Frame  
Frosted Glazing  
**Z1**  
Please specify:  
Z30S43TC - **Z1**

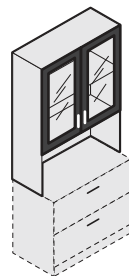

Black Frame  
Frosted Glazing  
**Z2**  
Please specify:  
Z30S43TC - **Z2**

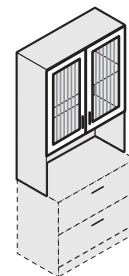

Silver Frame  
Ribbed Glazing  
**Z3**  
Please specify:  
Z30S43TC - **Z3**

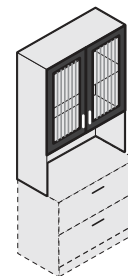

Black Frame  
Ribbed Glazing  
**Z4**  
Please specify:  
Z30S43TC - **Z4**

# WALL MOUNTED TACKBOARDS

84" ht.

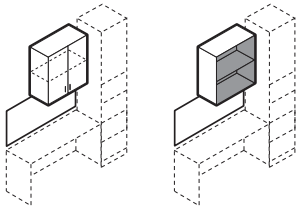

**ZWHTxx21**  
ZxxS330S/OSN - 84"/84.5" overall

71½" ht.

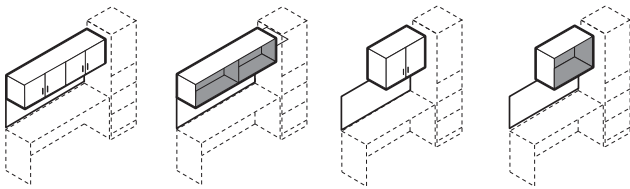

**ZWHTxx25**  
ZxxS160S/OSN - 71.5"/72" overall

**ZWHTxx21**  
ZxxS200S/OSN - 71.5"/72" overall

65" ht.

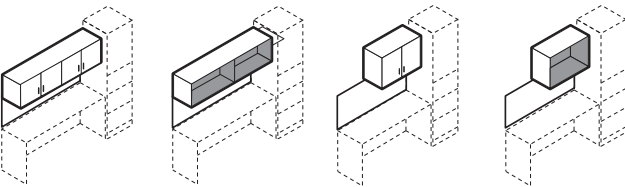

**ZWHTxx18**  
ZxxS160S/OSN - 65"/65.5" overall

**ZWHTxx14**  
ZxxS200S/OSN - 65"/65.5" overall

## Global US Headquarters/Distribution Center

17 West Stow Road, P.O. Box 562  
Marlton, New Jersey U.S.A. 08053  
T (856) 596-3390  
T (800) 220-1900  
F (856) 596-5684

A \$25 net handling charge per shipment  
will be applied for non-UPSable orders of  
less than \$2,000 list.

## Showrooms

### Atlanta

10 10th Street  
Suite 150  
Atlanta, GA 30309  
T (404) 879-0998  
F (404) 879-9995

### Boston

One Harbor Street  
Suite 104  
Boston, MA 02210  
T (617) 406-5435  
F (617) 406-5438

### Chicago

The Merchandise Mart  
222 Merchandise Mart Plaza  
10th Floor, Suite 1035  
Chicago, IL 60654  
T (312) 755-0843  
F (312) 755-0837

### Detroit Area

25925 Telegraph Road  
Suite 145  
Southfield, MI 48034  
T (248) 357-7211  
F (248) 357-7241

### Ft. Lauderdale

Las Olas City Centre  
401 East Las Olas Blvd.  
Suite 230  
Ft. Lauderdale, FL 33301  
T (954) 763-2684  
T (800) 331-0529  
T (954) 763-6870

### New York City

386 Park Avenue South  
7th floor  
New York, NY 10016  
T (212) 545-9900  
T (888) 315-1301  
F (212) 545-5826

### Philadelphia Area

119 Greentree Road  
Marlton, NJ 08053  
T (856) 596-3390  
T (800) 220-1900  
F (856) 596-4472

### Phoenix

4675 E Cotton Center Blvd.  
Suite 165  
Phoenix, AZ 85040  
T (602) 426-0666  
T (602) 426-0777  
F (602) 426-1148

### St. Louis

5 Document Drive  
St. Louis, MO 63114  
T (314) 432-4463  
F (314) 432-4471

### Washington, DC

1130 Connecticut Avenue  
10th Floor, Suite 1000  
Washington, DC 20036  
T (202) 659-0230  
T (202) 659-0236  
F (202) 659-0306

## Distribution Centers

### Atlanta Area

2124 Evergreen Blvd.  
Duluth, GA 30096  
T (678) 602-4130  
T (800) 220-7328  
F (678) 602-4136

### Baltimore Area

Troy Hill Corporate Center  
7030 Troy Hill Drive  
Elkridge, MD 21075  
T (410) 379-8021  
T (800) 863-7300  
F (301) 362-9444

### Boston Area

19 Connector Road  
Unit 1  
Andover, MA 01810  
T (978) 470-8463  
T (800) 876-8980  
F (978) 470-8920

### Chicago Area

1879 Internationale Blvd.  
Glendale Heights, IL 60139  
T (630) 681-2818  
T (800) 866-6497  
F (630) 681-1631

### Cincinnati Area

8712 LeSaint Drive  
Fairfield, OH 45014  
T (513) 777-0009  
T (800) 552-3375  
F (513) 777-5863

### Dallas Area

2025 West Beltline Road  
#100  
Carrollton, TX 75006  
T (972) 236-1366  
T (800) 929-2936  
F (972) 236-1372

### Denver Area

16401 East 33rd Drive  
Suite 50  
Aurora, CO 80011  
T (303) 340-1617  
T (800) 275-6655  
F (303) 340-1657

### Ft. Lauderdale Area

560 Sawgrass Corp. Pkwy  
Sunrise, FL 33325  
T (954) 846-8888  
T (800) 331-0529  
F (954) 846-8110

### Houston Area

7865 Northcourt Road  
Building D, Suite 200  
Houston, TX 77040  
T (713) 695-5777  
T (800) 935-6468  
F (713) 695-5778

### Los Angeles Area

12320 Bloomfield Avenue  
Unit A  
Santa Fe Springs, CA 90670  
T (562) 484-9686  
T (800) 640-0301  
F (562) 484-9685

### Minneapolis Area

2000 Freeway Boulevard  
Brooklyn Center, MN 55430  
T (763) 560-8196  
T (800) 829-2153  
F (763) 560-2098

### New Orleans Area

901 South Labarre Road  
Suite 201  
Metairie, LA 70001  
T (504) 834-6228  
T (800) 275-0663  
F (504) 835-9638

### Pittsburgh Area

380 Leetsdale Industrial Dr.  
Leetsdale, PA 15056  
T (724) 385-1200  
T (800) 942-9999  
F (724) 385-1207

### San Antonio Area

6950 Alamo Downs Pkwy  
Suite 100  
San Antonio, TX 78238  
T (210) 684-8450  
T (800) 683-4000  
F (210) 684-3700

### San Francisco Area

44091 Nobel Drive  
Fremont, CA 94538  
T (510) 897-4150  
T (888) 418-4800  
F (510) 897-4156

### Seattle Area

Oakesdale Commerce Ctr.  
820 Southwest 34th Street  
Building W7, Suite A  
Renton, WA 98057  
T (425) 291-9282  
T (888) 218-2600  
F (425) 291-9287

### Kansas City Area

11617 West 81st Street  
Lenexa, KS 66214  
T (913) 310-9963  
T (800) 796-0770  
F (913) 310-9976

### Tampa Area

10351 Windhorst Road  
Tampa, FL 33619  
T (813) 621-6272  
T (877) 707-3966  
F (813) 621-7958



globalfurnituregroup.com

